

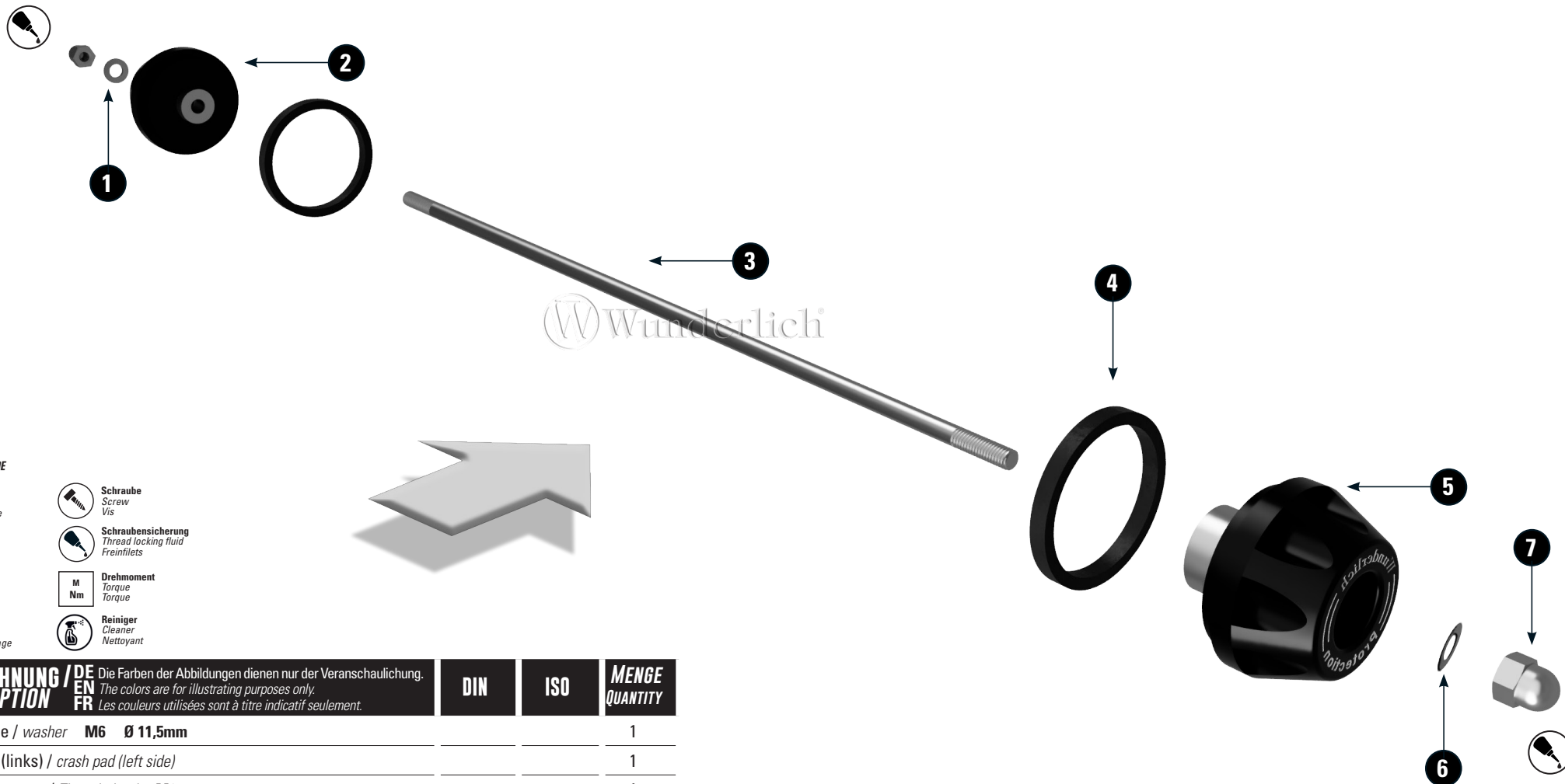







# ACHSSCHUTZPAD

axle protection pad | almohadilla de protección del eje | tampon de protection de l'axe | cuscinetto di protezione dell'asse

Art.-Nr: 90250-00X



## LEGENDE/KEY/FILE LEGENDE

-  **Anbau Tipp**  
Fitting tip  
Astuce de montage
-  **Achtung**  
Attention  
Attention
-  **Vergrößerung**  
Magnification  
Grossissement
-  **Montagepaste**  
Fitting lubricant  
Lubrifiant de montage
-  **Schraube**  
Screw  
Vis
-  **Schraubensicherung**  
Thread locking fluid  
Freiniflets
-  **Drehmoment**  
Torque  
Torque
-  **Reiniger**  
Cleaner  
Nettoyant

#	BEZEICHNUNG / DESCRIPTION DE / EN / FR	DIN	ISO	MENGE / QUANTITY
1	U-Scheibe / washer M6 Ø 11,5mm			1
2	Sturzpad (links) / crash pad (left side)			1
3	Gewindestange / Threaded rod M6			1
4	Gummidichtung / sealing rubber			2
5	Sturzpad (rechts) / crash pad (right side)			1
6	U-Scheibe / washer M6 Ø 17,0mm			1
7	Hutmutter / cap nut M6			2

Die Farben der Abbildungen dienen nur der Veranschaulichung.  
The colors are for illustrating purposes only.  
Les couleurs utilisées sont à titre indicatif seulement.



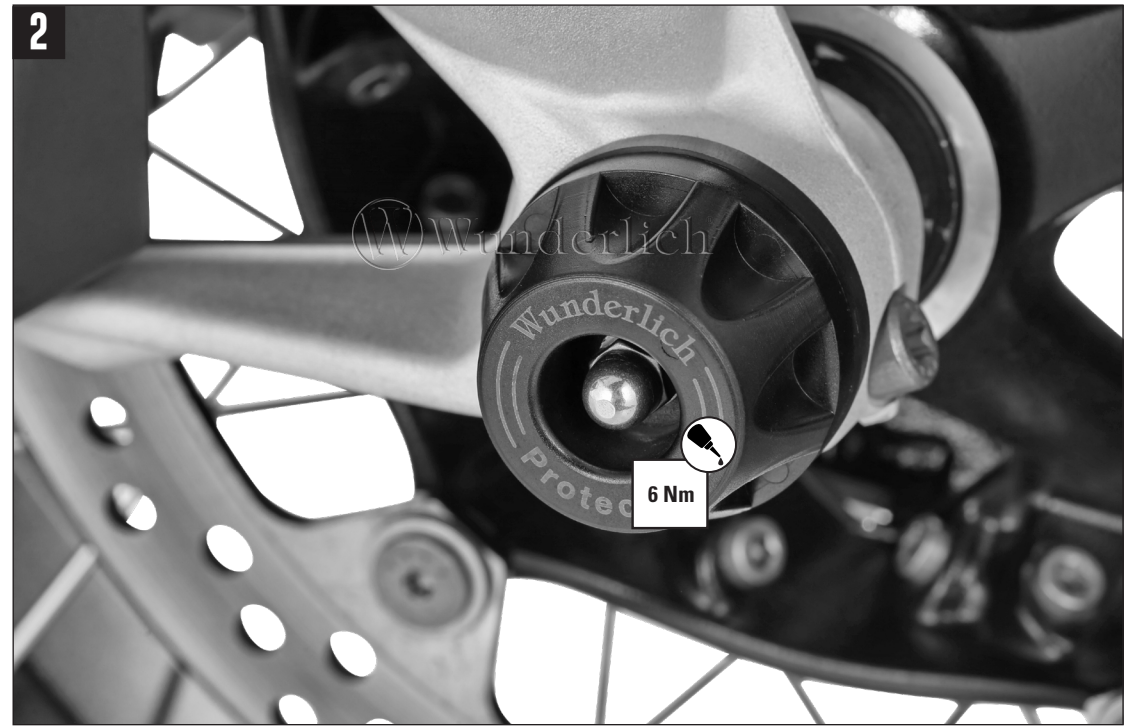

**INNENSEITE BEACHTEN**

*Note inside*