

KOFFERTRÄGER EXTREME

Case carrier Extreme | Portamaletas Extreme | Porte-bagages Extreme | Supporto per valigie Extreme

Art.-Nr: 71600-10X

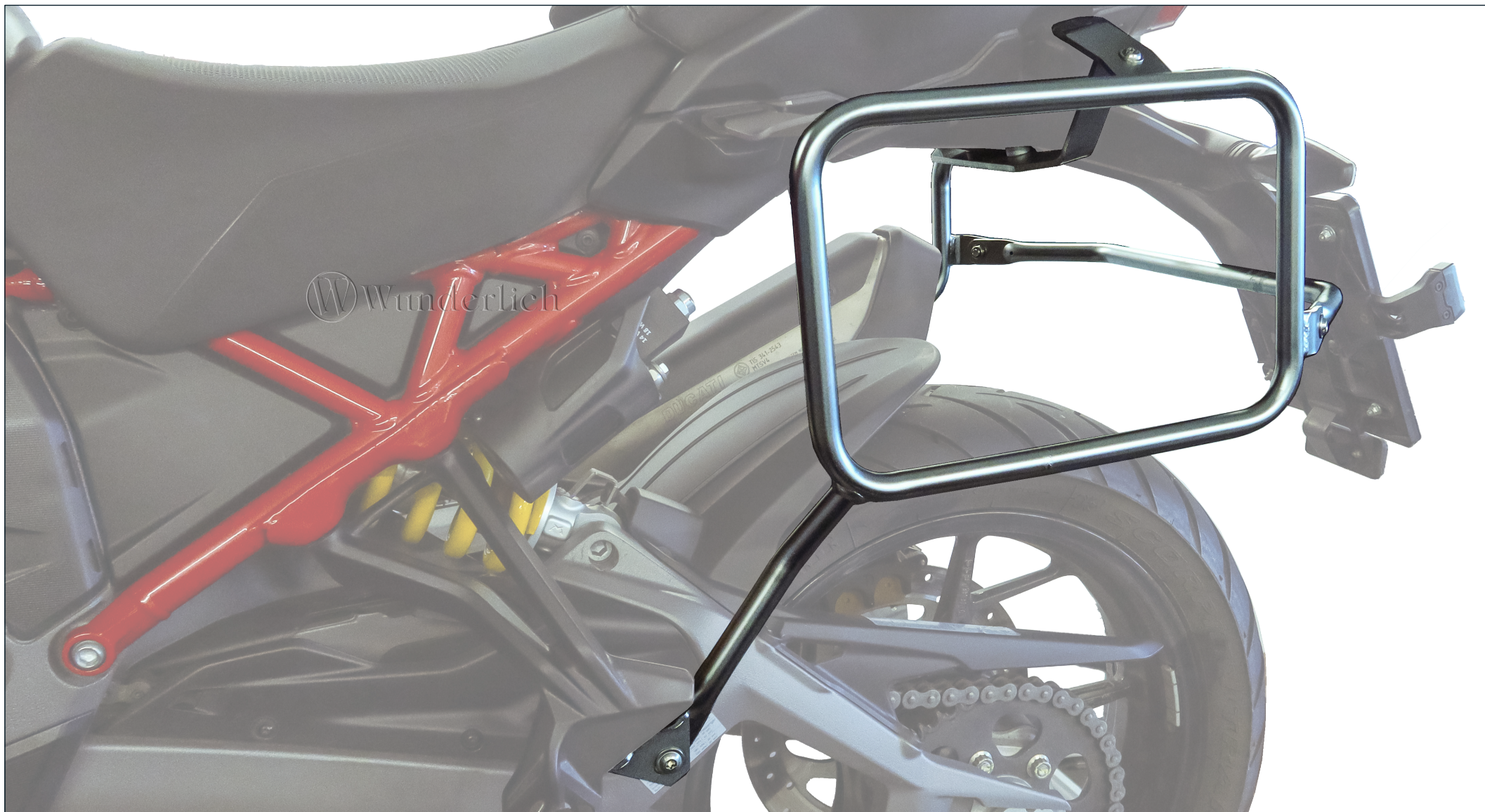

07.01.26



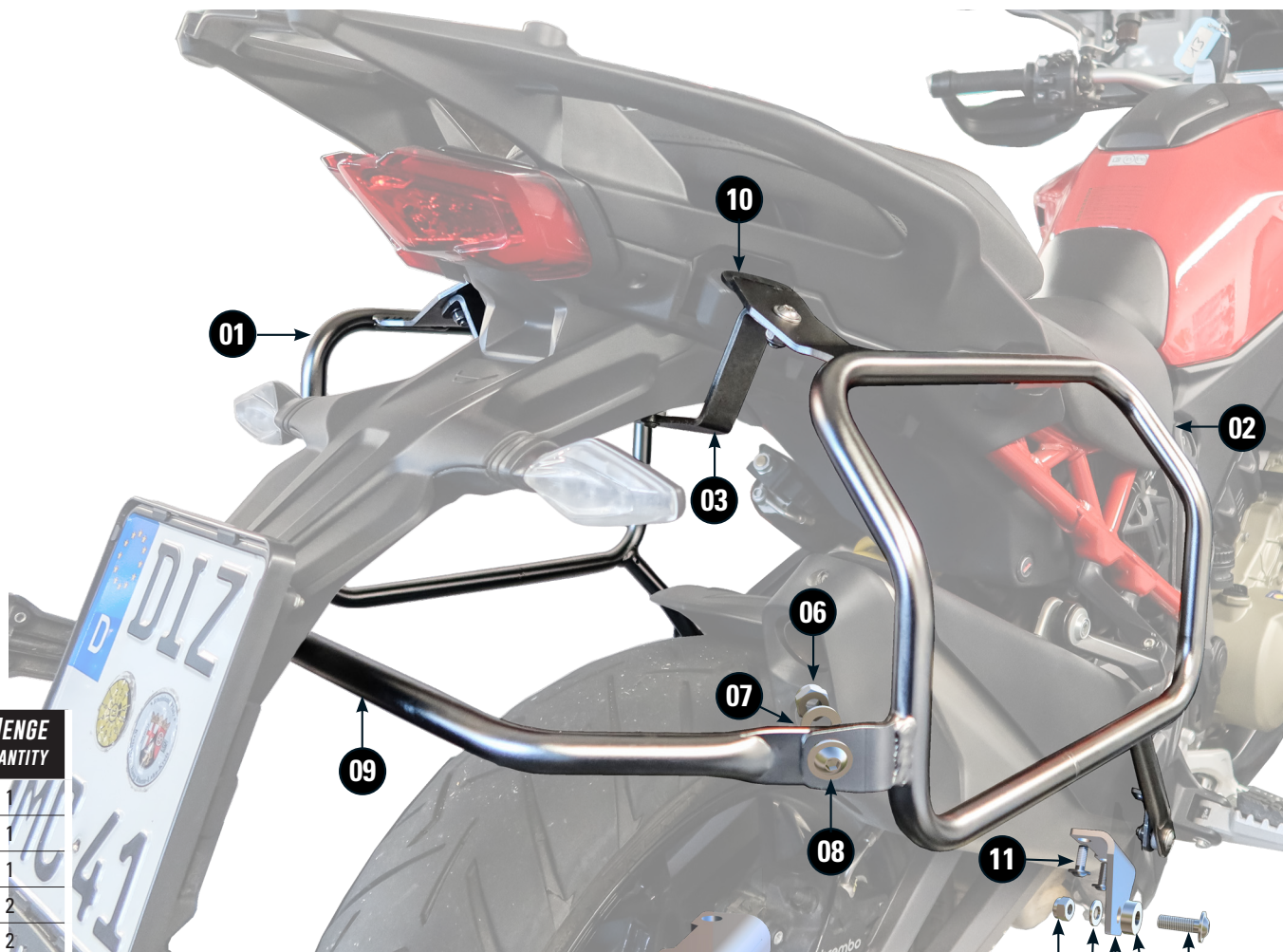
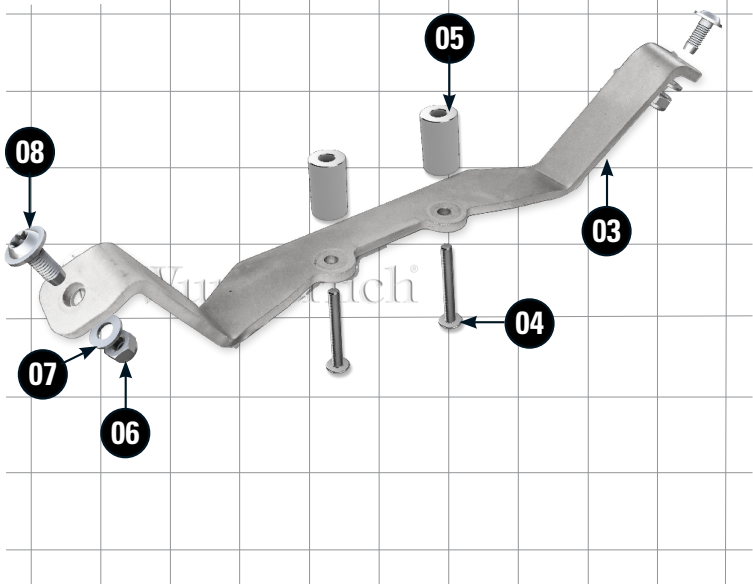

#	BEZEICHNUNG / DESCRIPTION	DIN	ISO	MENGE QUANTITY
1	Kofferträger links / Carrier left side			1
2	Kofferträger rechts / Carrier right side			1
3	Halter 1 / Bracket 1			1
4	Linsenflanschschraube / Lens head screw M6 x 20	7381A2	7381A2	2
5	Hülse / Sleeve ØD 18,0 - Ød 7,0 - h 35,0mm			2
6	Sechskantmutter / Hexagon nut	985A2	10511	4
7	U-Scheibe / Washer M8			4
8	Linsenflanschschraube / Lens head screw M8 x 20	7381A2	7381A2	4
9	Verbindungsstrebe / Compound strut			1
10	Gummi-Stopfen / Plug			4
11	Linsenflanschschraube / Lens head screw M6 x 16	7381A2	7381A2	4
12	Halter 2 / Bracket 2			2
13	Hülse / Sleeve ØD 20,0 - Ød 8,5 - h 7,0 mm			1
14	Linsenflanschschraube / Lens head screw M8 x 25	7381A2	7381A2	4
15	Hülse / Sleeve ØD 20,0 - Ød 8,5 - h 9,0 mm			1
16	Schraubensicherung / Thread locking fluid			1

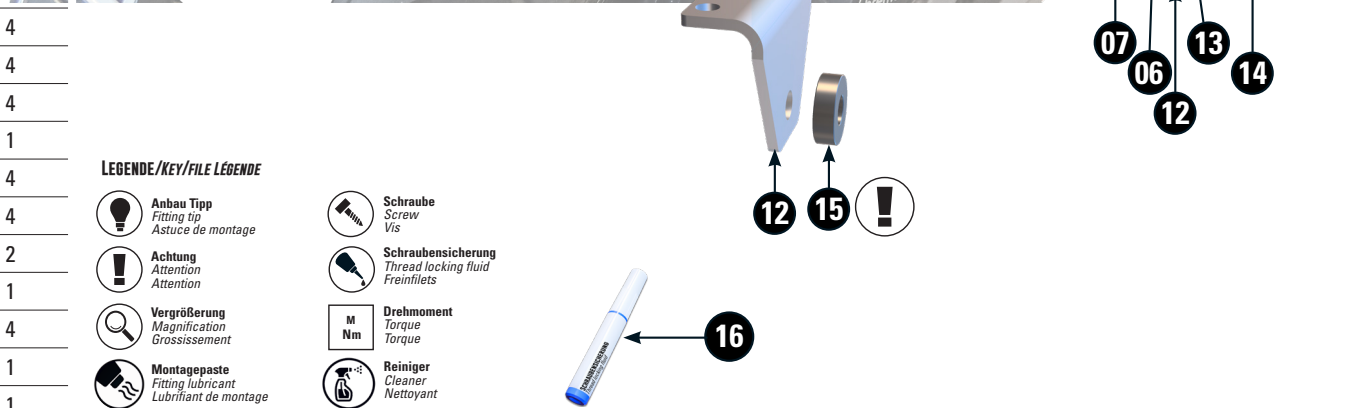

LEGENDE/KEY/FILE LÉGENDE

- Anbau Tipp**
Fitting tip
Astuce de montage
- Achtung**
Attention
Attention
- Vergrößerung**
Magnification
Grossissement
- Montagepaste**
Fitting lubricant
Lubrifiant de montage

- Schraube**
Screw
Vis
- Schraubensicherung**
Thread locking fluid
Freinfiets
- Drehmoment**
Torque
Torque
- Reiniger**
Cleaner
Nettoyant

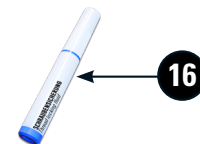

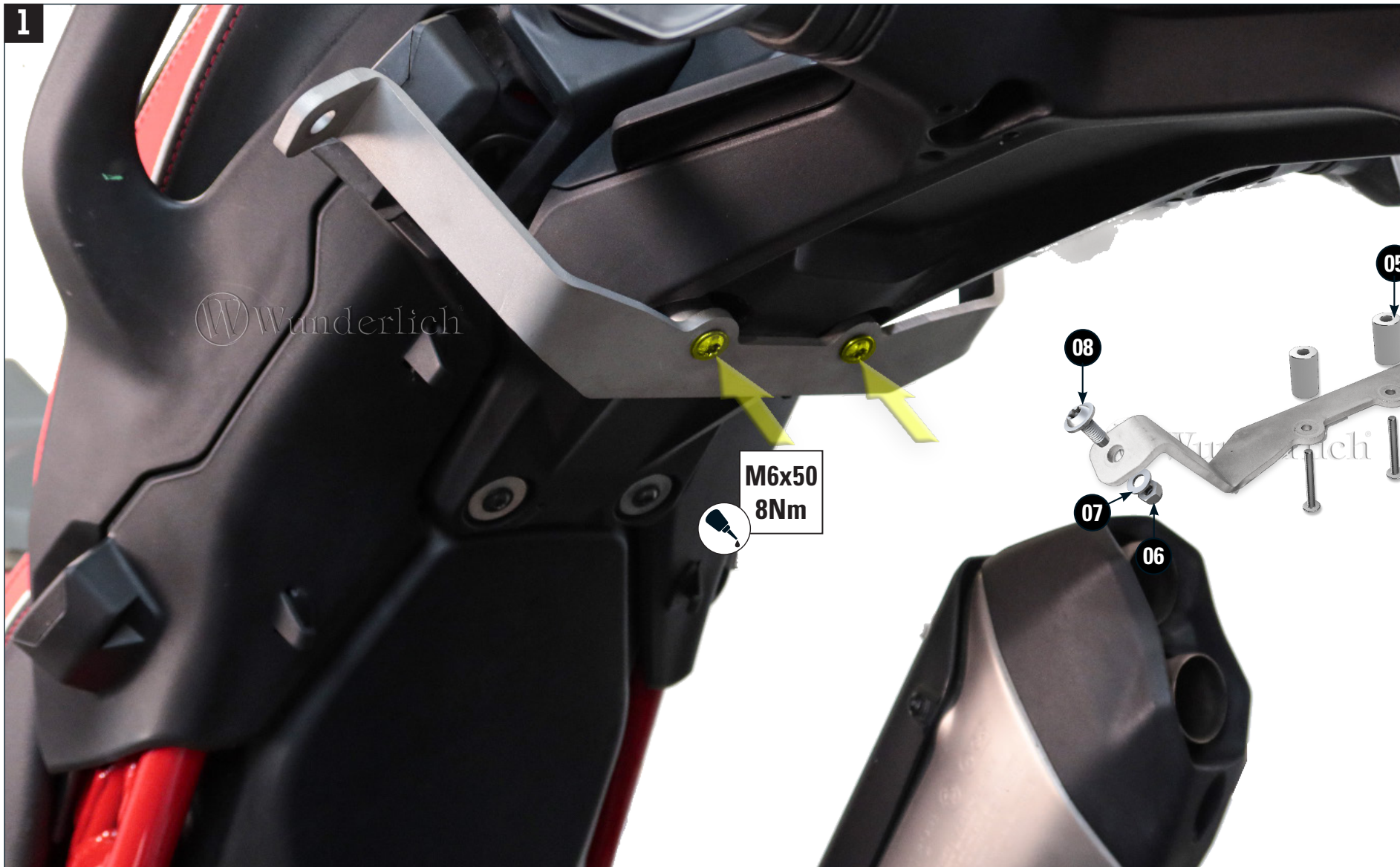

Bitte alle Anbauteile lose am Fahrzeug vormontieren und ausrichten. Erst danach die Schrauben nach Vorgabe anziehen.
First, tighten all screws only loosely. After mounting all parts, the screws should be tightened to the torque specified.
Tout d'abord, ne serrez pas toutes les vis sans les serrer. Après avoir monté toutes les pièces, les vis doivent être serrées au couple spécifié.

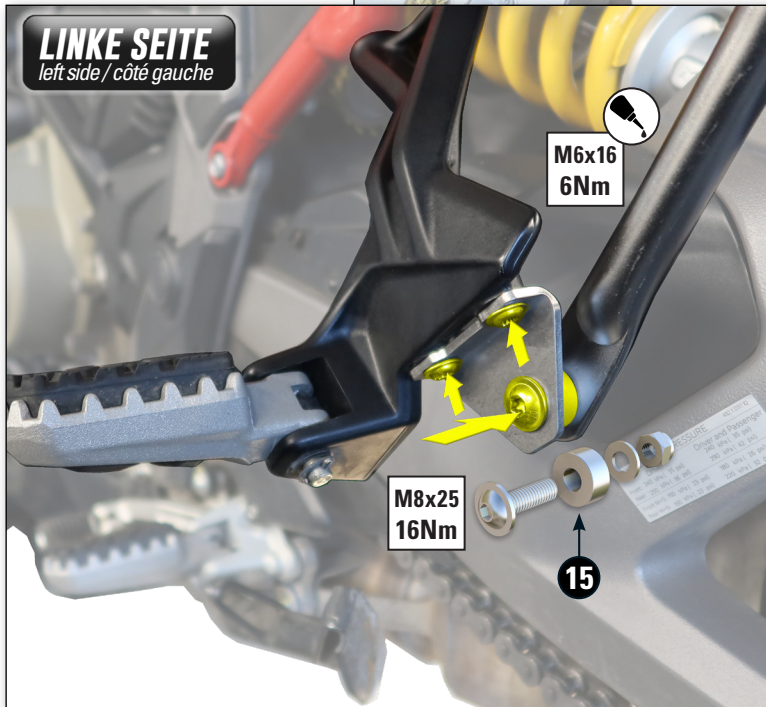
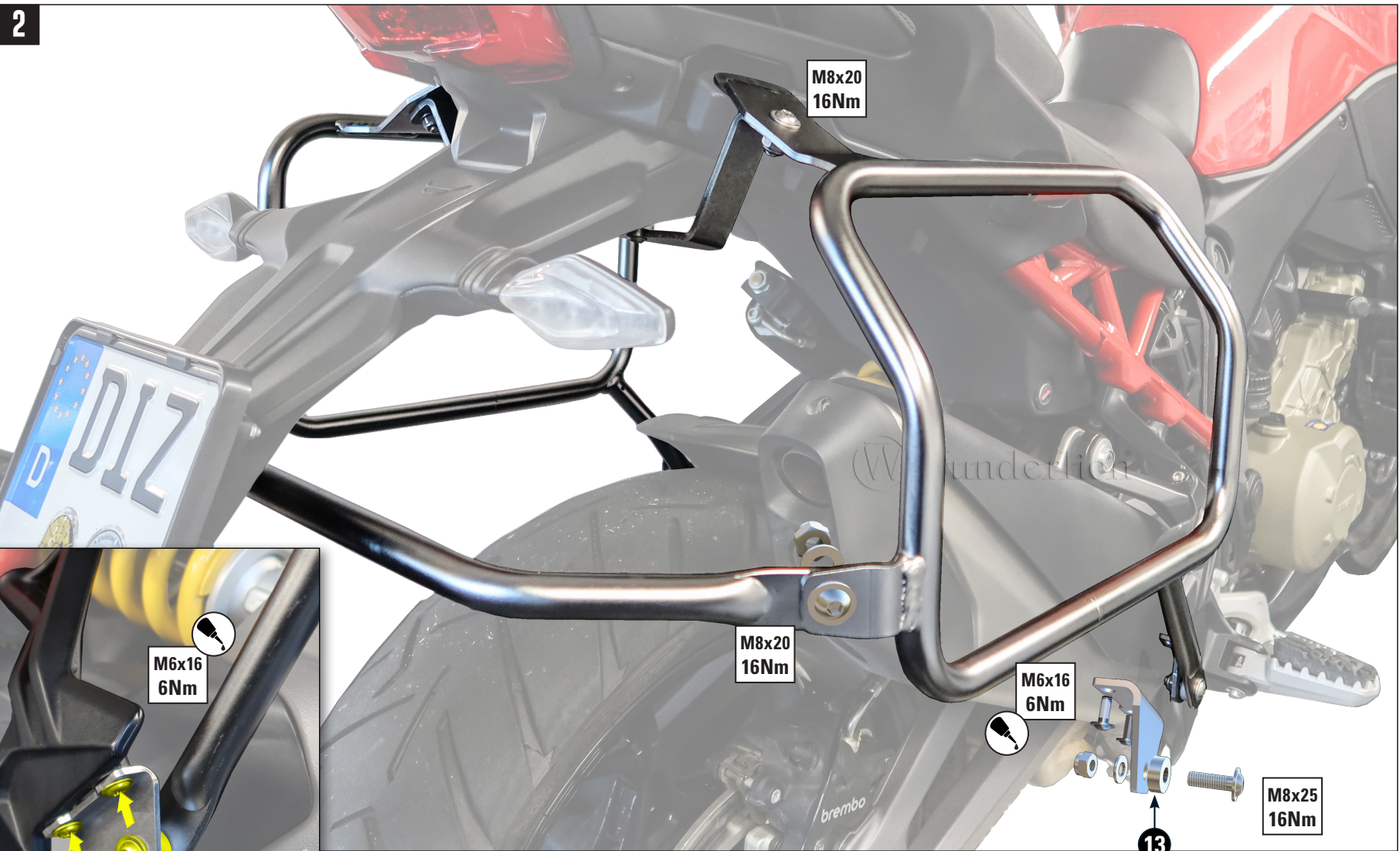

3

180

10 KG



Verriegelung des Koffers und die Verschraubung des Trägers, vor Fahrtantritt prüfen. Verschlüsse der Deckel müssen verriegelt sein. Empfohlenes Tempolimit mit Zuladung 180 km/h. Ungleichmäßiges oder unsachgemäßes Beladen kann das Fahrverhalten negativ beeinflussen.

Check before each journey that case/top case is securely attached to the carrier on the vehicle. Locks must be closed.

Recommended speed limit with load: 180 km/h (111 mph). Uneven or improper loading can affect the driving behaviour in a negative way.

Avant chaque voyage, vérifiez que la valise/le top case est bien fixé(e) au porte-bagages du véhicule. Les serrures doivent être fermées.

Limite de vitesse recommandée avec charge : 180 km/h (111 mph). Un chargement irrégulier ou incorrect peut avoir des conséquences négatives sur le comportement de conduite.

