

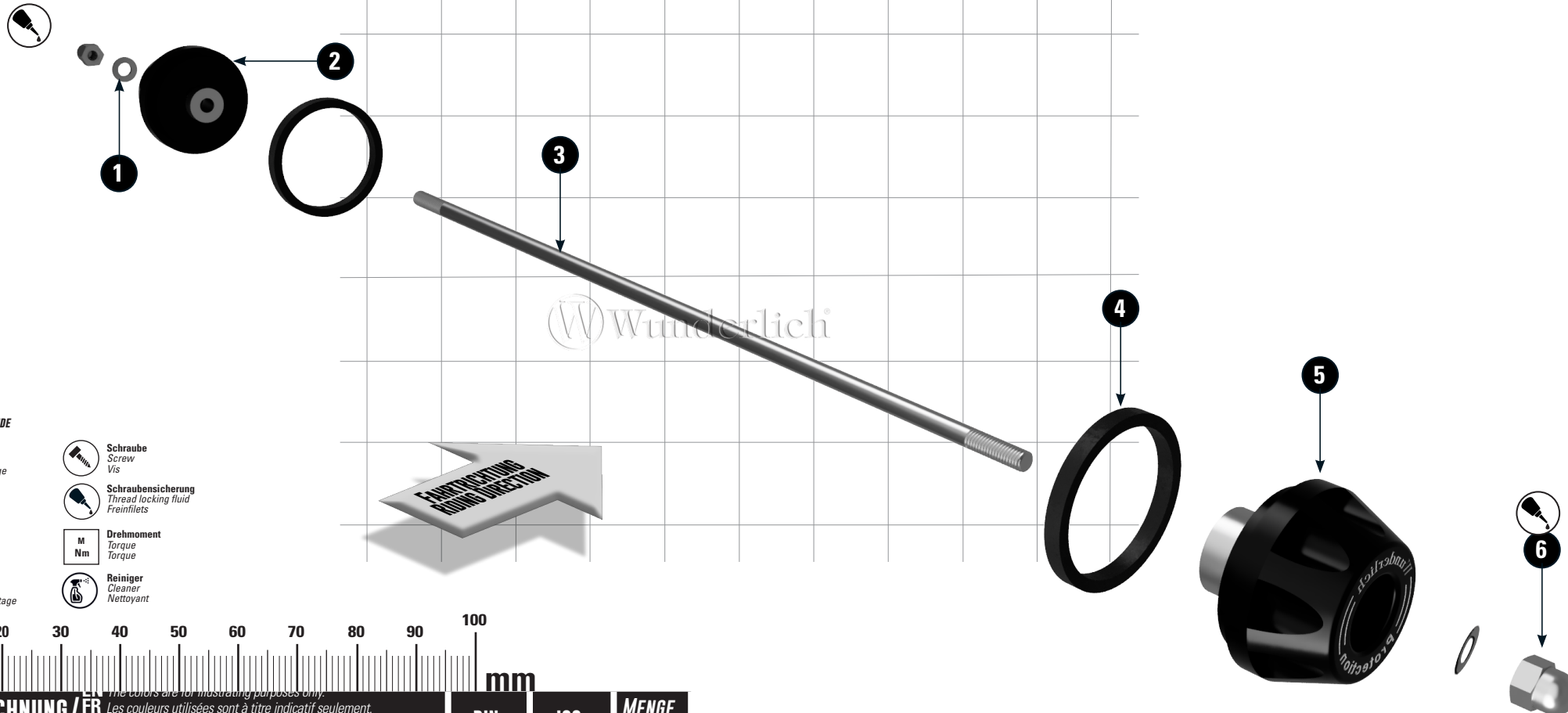







ACHSSCHUTZPAD

axle protection pad | almohadilla de protección del eje | tampon de protection de l'axe | cuscinetto di protezione dell'asse

Art.-Nr: 70250-002 / 71250-002 / 71252-002



LEGENDE/KEY/FILE LÉGENDE

-  **Anbau Tipp**
Fitting tip
Astuce de montage
-  **Achtung**
Attention
Attention
-  **Vergrößerung**
Magnification
Grossissement
-  **Montagepaste**
Fitting lubricant
Lubrifiant de montage
-  **Schraube**
Screw
Vis
-  **Schraubensicherung**
Thread locking fluid
Freinfilets
-  **Drehmoment**
Torque
Torque
-  **Reiniger**
Cleaner
Nettoyant

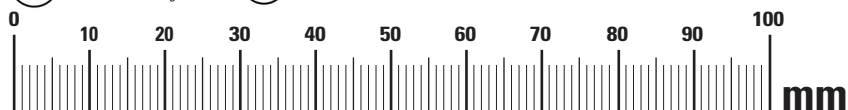

#	BEZEICHNUNG / FR DESCRIPTION	DIN	ISO	MENGE QUANTITY
1	U-Scheibe / washer M6 Ø 17,0mm	7349A2-6	4759A2-6	2
2	Sturzpadd (links) / crash pad (left side)			1
3	Gewindestange / Threaded rod M6			1
4	Gummidichtung vormontiert / sealing rubber pre-assembled			2
5	Sturzpadd (rechts) / crash pad (right side)			1
6	Hutmutter / cap nut M6			2

6Nm

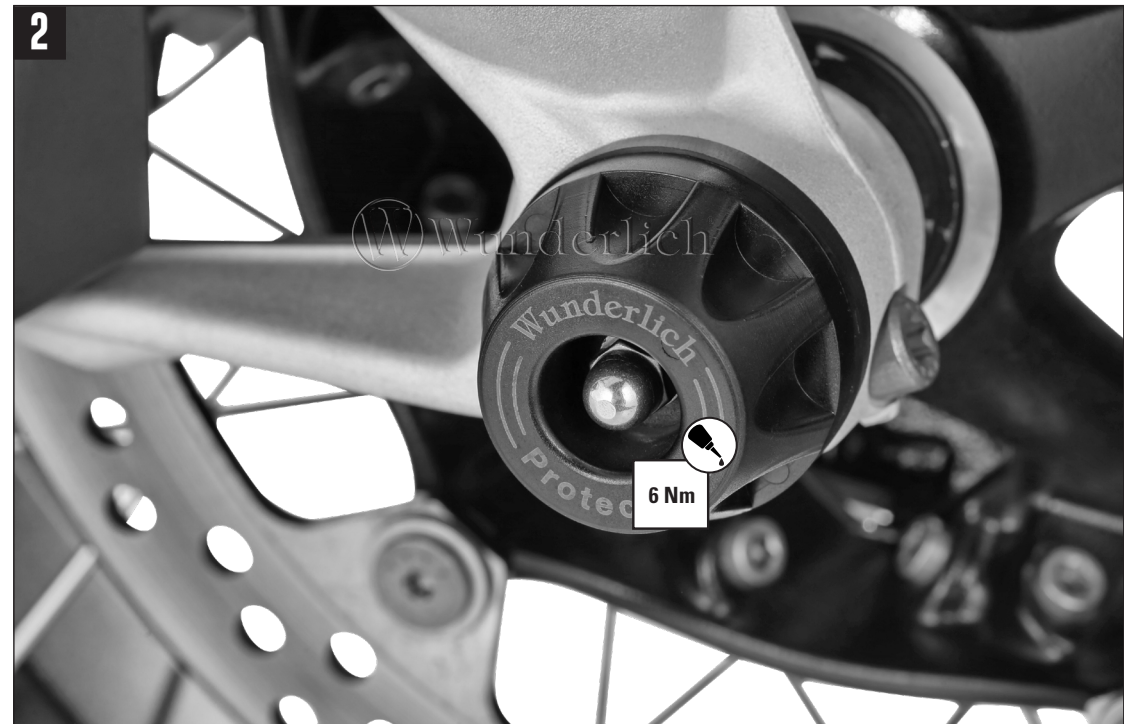

INNENSEITE BEACHTEN

Note inside