

LED - MICROFLOOTER 3.0

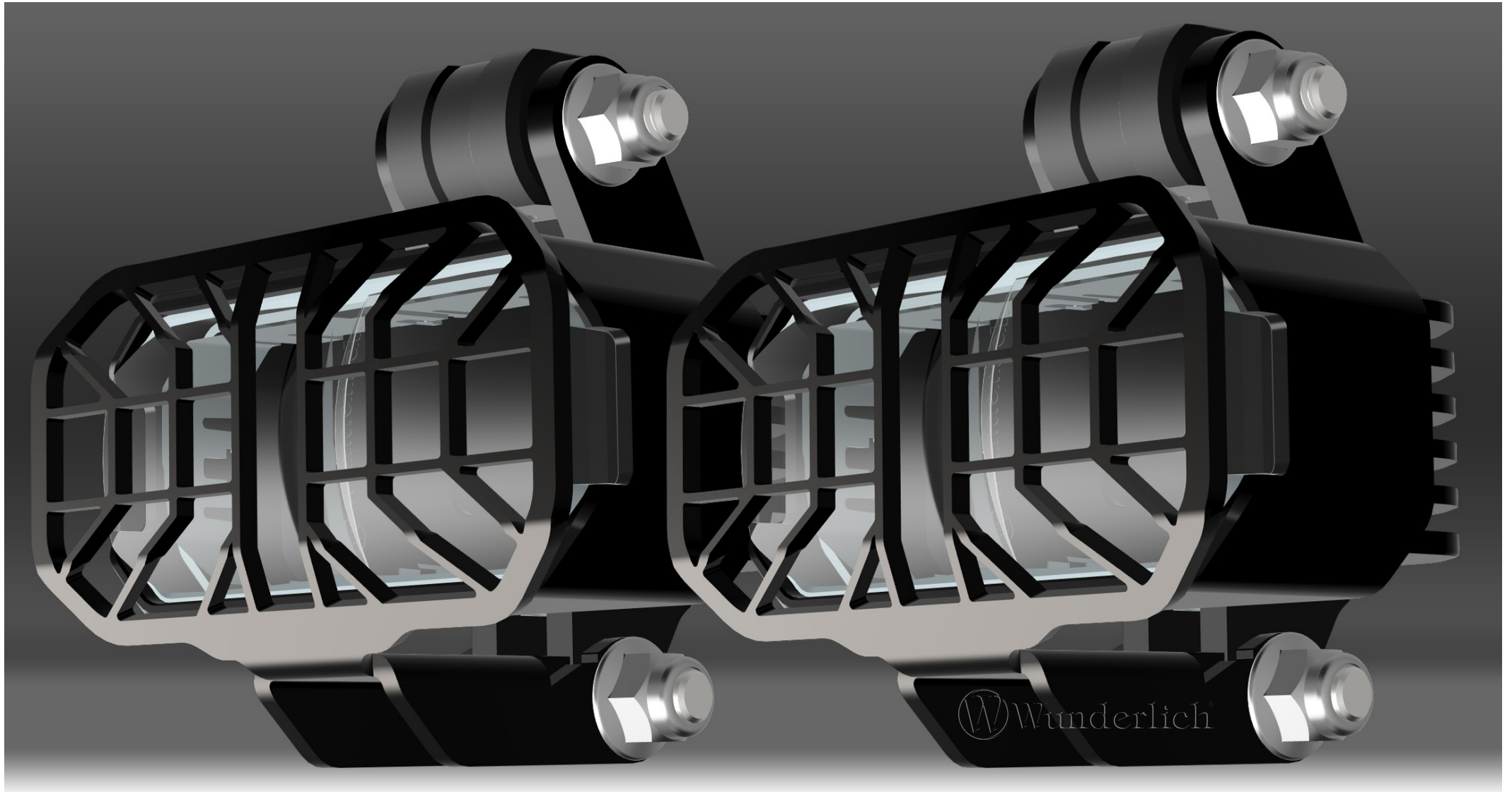

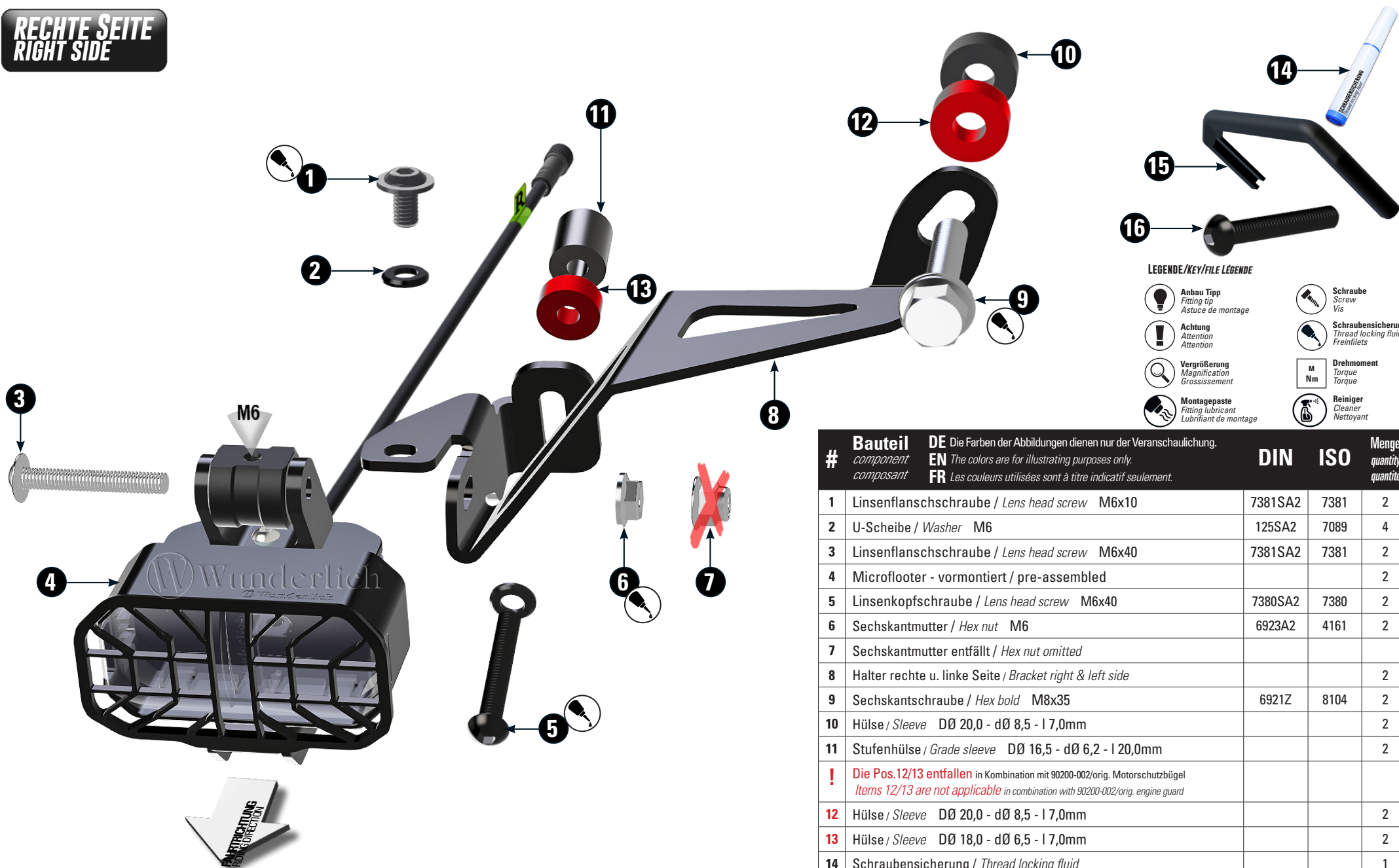





Art.-Nr: 90290-00X



**RECHTE SEITE
RIGHT SIDE**



LEGENDE/KEY/FILE LÉGENDE

-  **Anbau Tipp**
Fitting tip
Astuce de montage
-  **Achtung**
Attention
Attention
-  **Vergrößerung**
Magnification
Grossissement
-  **Montagepaste**
Fitting lubricant
Lubrifiant de montage
-  **Schraube**
Screw
Vis
-  **Schraubensicherung**
Thread locking fluid
Freinfilets
-  **Drehmoment**
Torque
Torque
-  **Reiniger**
Cleaner
Nettoyant

#	Bauteil component composant	DE Die Farben der Abbildungen dienen nur der Veranschaulichung. EN The colors are for illustrating purposes only. FR Les couleurs utilisées sont à titre indicatif seulement.	DIN	ISO	Menge quantity quantité
1	Linsenflanschschraube / Lens head screw	M6x10	7381SA2	7381	2
2	U-Scheibe / Washer	M6	125SA2	7089	4
3	Linsenflanschschraube / Lens head screw	M6x40	7381SA2	7381	2
4	Microfloater - vormontiert / pre-assembled				2
5	Linsenkopfschraube / Lens head screw	M6x40	7380SA2	7380	2
6	Sechskantmutter / Hex nut	M6	6923A2	4161	2
7	Sechskantmutter entfällt / Hex nut omitted				
8	Halter rechte u. linke Seite / Bracket right & left side				2
9	Sechskantschraube / Hex bolt	M8x35	6921Z	8104	2
10	Hülse / Sleeve	DØ 20,0 - dØ 8,5 - l 7,0mm			2
11	Stufenhülse / Grade sleeve	DØ 16,5 - dØ 6,2 - l 20,0mm			2
!	Die Pos.12/13 entfallen in Kombination mit 90200-002/orig. Motorschutzbügel Items 12/13 are not applicable in combination with 90200-002/orig. engine guard				
12	Hülse / Sleeve	DØ 20,0 - dØ 8,5 - l 7,0mm			2
13	Hülse / Sleeve	DØ 18,0 - dØ 6,5 - l 7,0mm			2
14	Schraubensicherung / Thread locking fluid				1
15	Kantenschutz / Edge protection				30cm
16	Linsenkopfschraube / Lens head screw	M6x35	7380SA2	7380	1



4

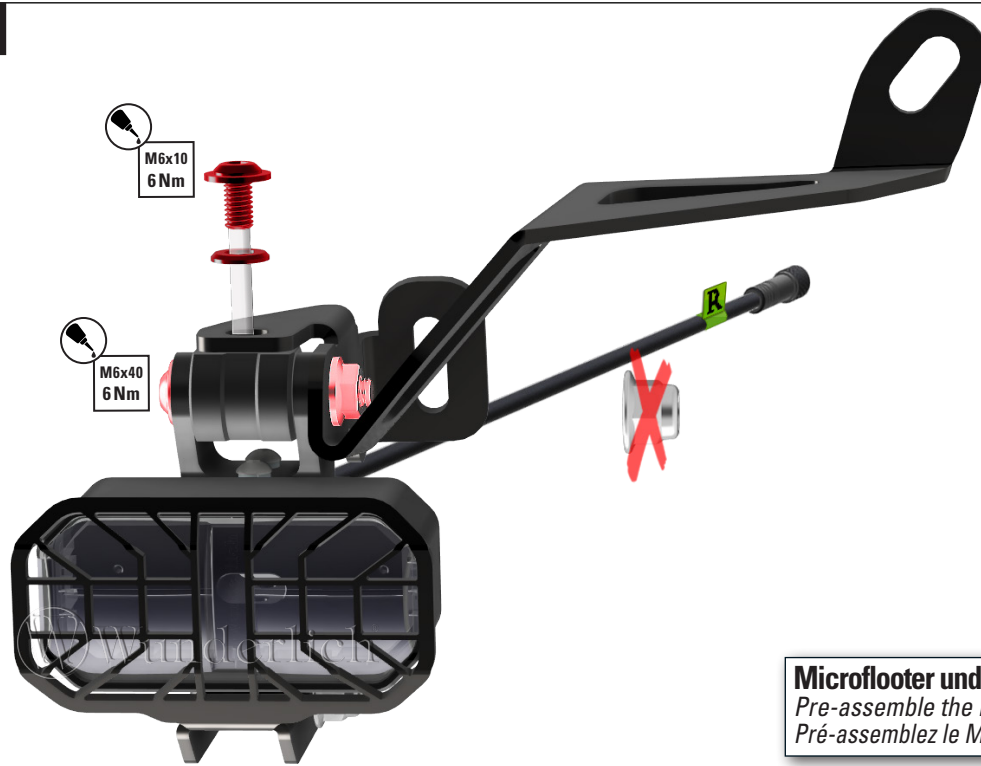

Microfloater und Halter vormontieren.
Pre-assemble the Microfloater and bracket.
Pré-assemblez le Microfloater et le support.

5

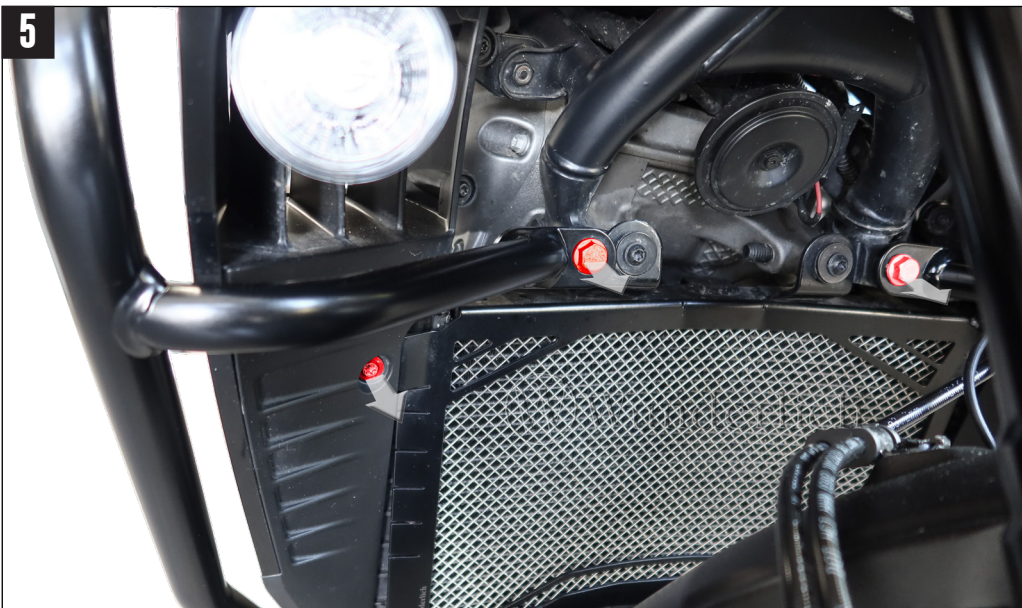

6



SCHALTPLAN

electrical layout / schéma électrique

- A** -Scheinwerfer
headlights / phares supplémentaires
- B** -(An-Aus Schalter)
(on/off switch) / (interrupteur on-off)
- C** -Anschluss
Connection /
- D** -Sicherung
fuse / fusible
- E** -Minus
minus
- F** -Plus
plus

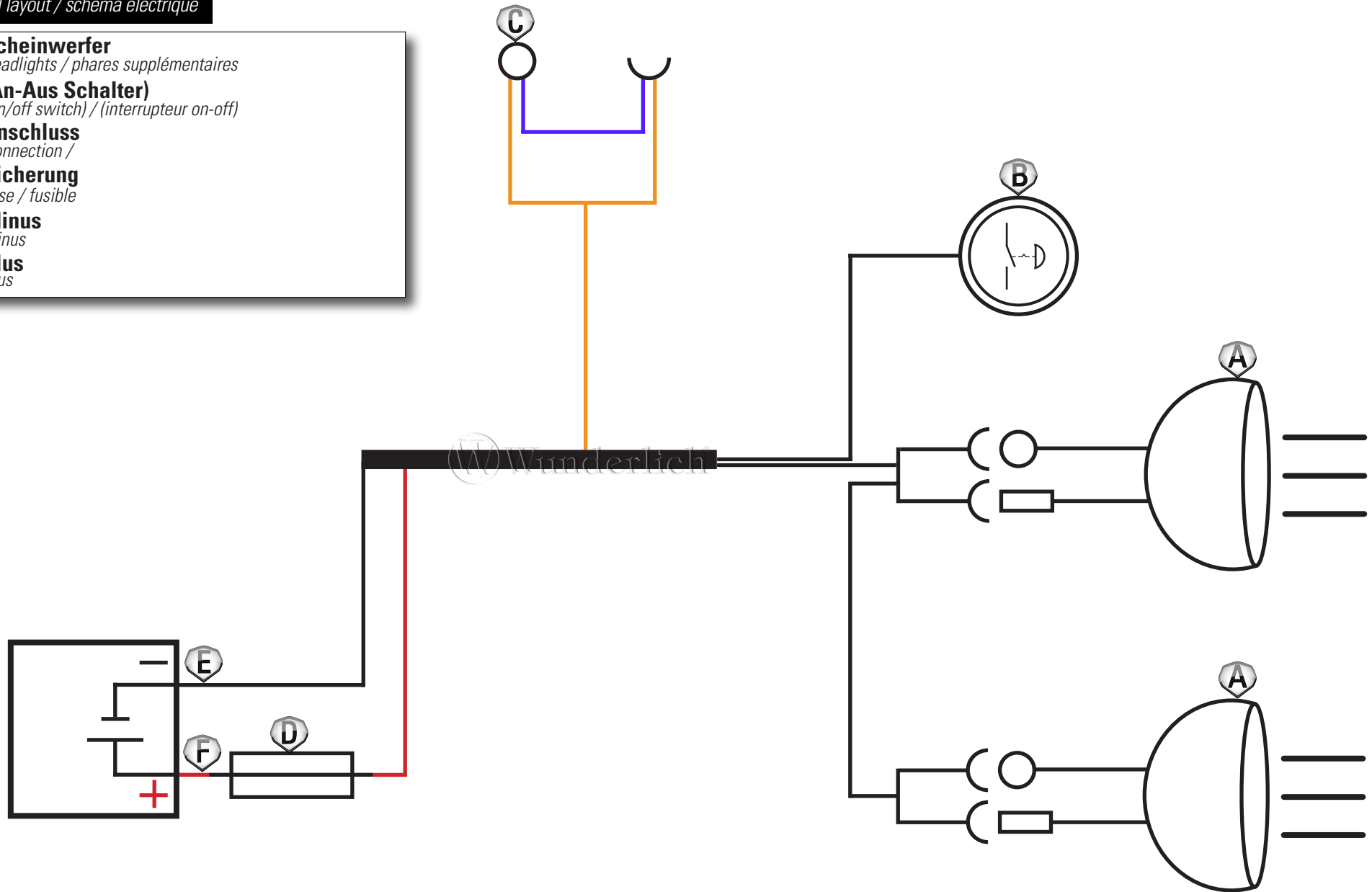

MONTAGEBEISPIEL
Mounting example
Exemple de montage

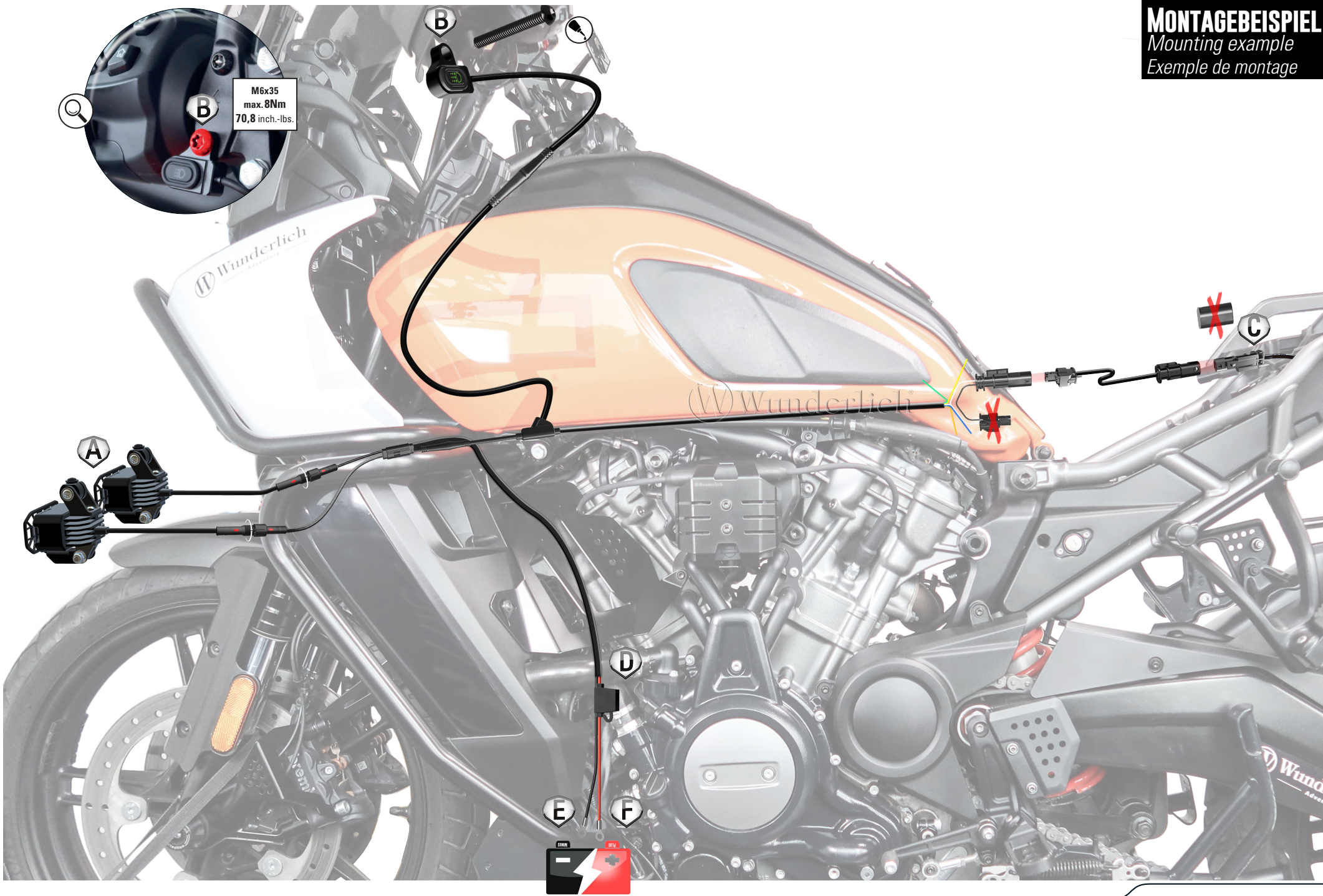

M6x35
max. 8Nm
70,8 inch.-lbs.





Wunderlich