

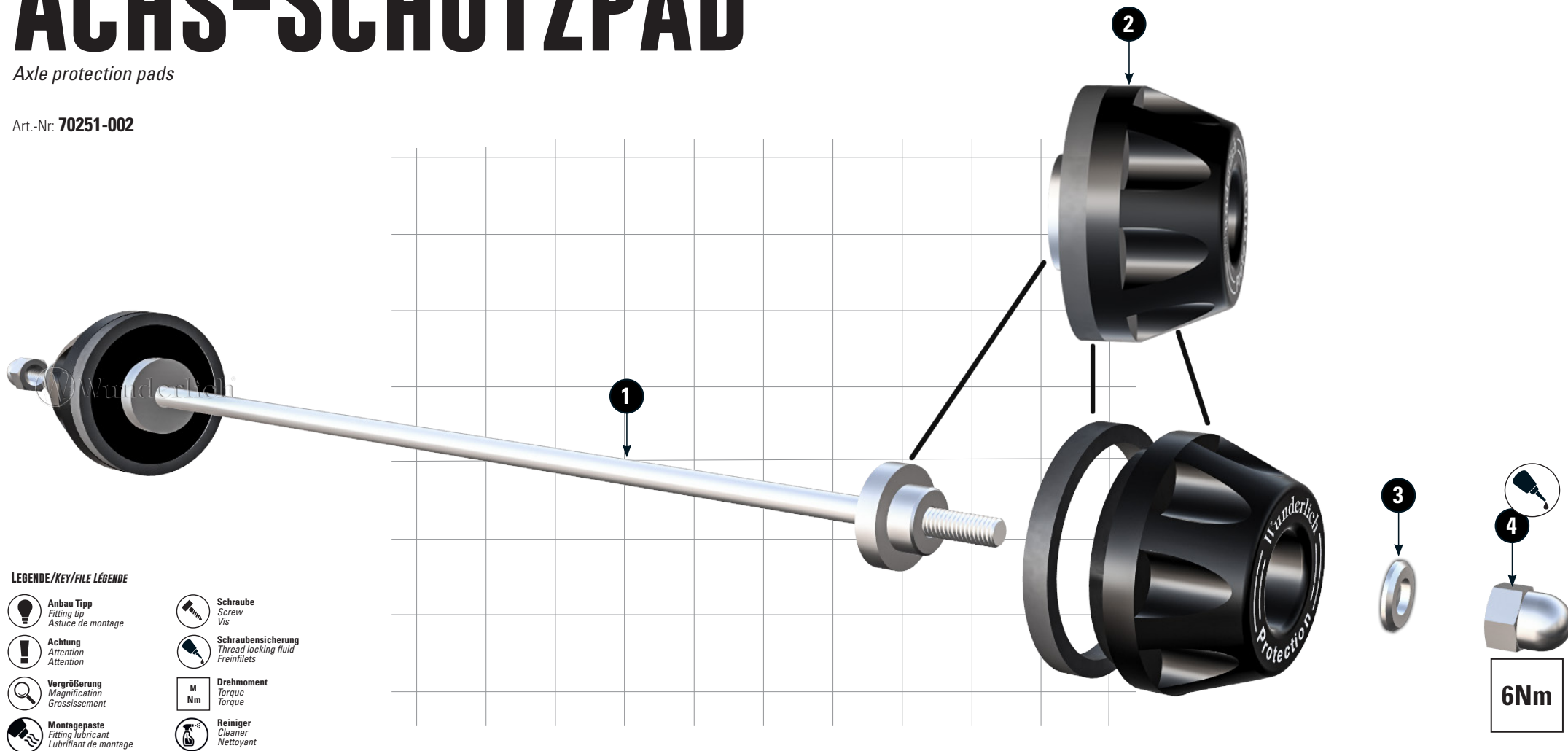







ACHS-SCHUTZPAD

Axle protection pads

Art.-Nr. **70251-002**



LEGENDE/KEY/FILE LÉGENDE

-  **Anbau Tipp**
Fitting tip
Astuce de montage
-  **Achtung**
Attention
Attention
-  **Vergrößerung**
Magnification
Grossissement
-  **Montagepaste**
Fitting lubricant
Lubrifiant de montage
-  **Schraube**
Screw
Vis
-  **Schraubensicherung**
Thread locking fluid
Freinfiets
-  **Drehmoment**
Torque
Torque
-  **Reiniger**
Cleaner
Nettoyant

#	Bauteil component composant	DE Die Farben der Abbildungen dienen nur der Veranschaulichung. EN The colors are for illustrating purposes only. FR Les couleurs utilisées sont à titre indicatif seulement.	DIN	ISO	Menge quantity quantité
1	Gewindestange / Threaded rod M6				1
2	Schutzpads linke & rechte Seite vormontiert Protection Pads Left & right Side pre-assembled				2
3	U-Scheibe / washer M6				2
4	Hutmutter / cap nut M6 6Nm				2
5	Schraubensicherung / Thread locking fluid				1



